



Shanghai Yuchang Industrial Co., Ltd.

CYCJET B SERIES

CIJ SMALL CHARACTER INKJET PRINTER

·SMART THINKING
·SMART PRINTING



CYCJET B SERIES CIJ SMALL CHARACTER INKJET PRINTER

B3020 B3020i B6040
B9080 BH3020 BW3020



INTRODUCE



CYCJET B series small character inkjet printer can achieve a max of 32 dot matrix printing. The high-resolution display and operation interfaces in Chinese, English, Arabic, Russian, Thai, Italian, and other languages enable users to quickly achieve the required functions and greatly improve the operation time. The innovative design of the circuit system, ink system, and nozzles enables the printer to achieve higher stability, and the nozzles are automatically cleaned at the end of each cycle to achieve reliable start/stop performance without the need for daily cleaning. Widely used in high-speed production lines for food, beverages, alcohol, daily chemicals, petroleum, cables, pipes, etc.

HIGHLIGHTS

- Industrial grade design concept all stainless steel body, IP54 level.
- Integrated motherboard design to avoid circuit failures caused by aging connectors.
- Multilingual software, one-key switching.



PARAMETERS

Item \ Model	B3020	B6040/B3020i	Bh3020	Bw3020	B9080
Nozzles	32dots				40dots
Nozzle Size	40/50/60/70u				
Operation Interface	Keyboard	Touch Screen	Keyboard	Keyboard	Touch Screen
Printing Lines	1-5 line				1-6 lines
Printing Fonts	5×5, 5×7, 7×9, 12×16, 18×24, 12×12, 16×16, Customized Fonts Supported				
Printing Height	1.2-15mm				
Printing Speed	Max 345m/min		Max 500m/min		Max 345m/min
Ink System	Auto Self-cleaning				
Ink Supply Method	Ink Tank, Ink Cartridge(optional)				
Program	Standard, High Speed (optional)				
Language	Multi Languages				
Ink Color	Black, Blue, Red		Yellow, White (Pigment Ink)	Black, Blue, Red	
Protection Degree	Ip55 Industrial Protection				
External Interface	USB, Ethernet, RS232, Alarm Light				
Power Supply	100-240V, 50/60Hz				
Packing	56*45*62cm, 32.0kg				

DIMENSIONS

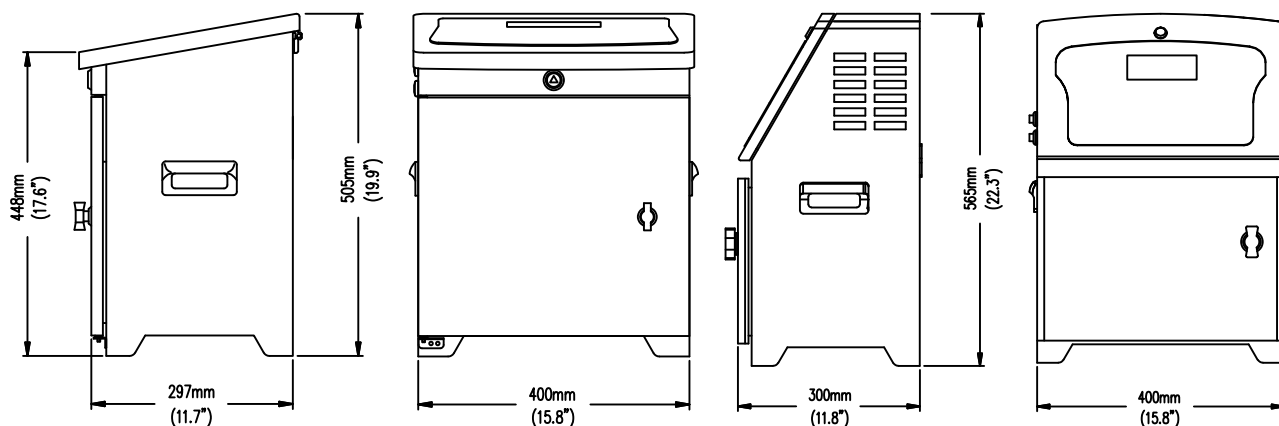

INK INTRODUCTION



- Fully enclosed modular ink system, suitable for various harsh environments.
- The automatic cleaning ink system design, greatly improves the performance of switching on and off.
- The ink refill system could refill and run simultaneously, without replacing the ink tank, saving running costs.

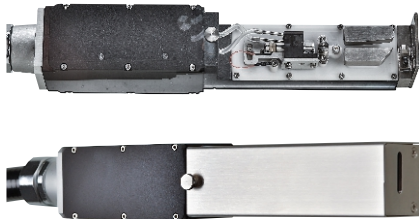

• Print Nozzle

- The automatic cleaning ink system design, greatly improves the performance of switching on and off.
- The anti-blocking nozzle design ensures the stability of the machine's continuous high-speed printing.
- The nozzle is structured without a PICO valve, which perfectly solves the problem of the high failure rate of the PICO valve.

DETAILS

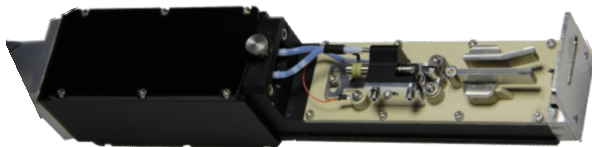

APPLICATIONS

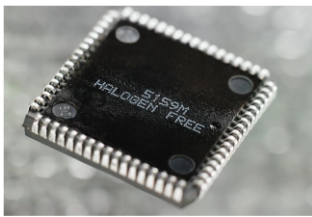

Chip

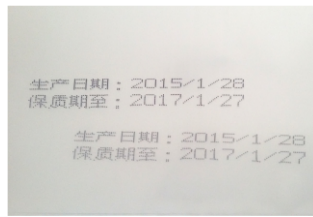

EPS Foam Sheet



HDPE Pipe White Ink

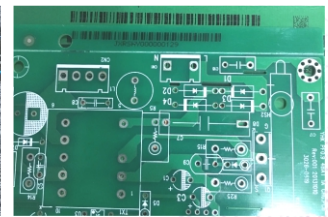

PCB Circuit Board



Packaging Box



Battery



Battery White Ink



Electronic Component



Pipe



Silicone Bottle



Egg



Metal Can



Metal Parts

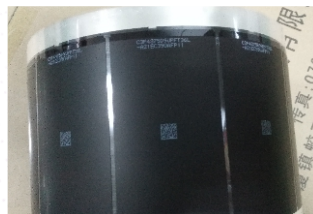

Metal Parts White Ink



Metal Bucket



Aluminium Can



Food



Plastic Packaging Bag



Pillbox



Cable

Simple Friendly
Reliable Smart

**CYCJET B Series
CIJ Small Character
Inkjet Printer**



Contact Us

Web: www.cycjet.com

TEL: +86-21-59970419

FAX: +86-21-59971610

Email: service@cycjet.com

ADD: 1/F, BLDG. 4, NO. 333 HUAGAO RD., HUATING

IND. ZONE, SHANGHAI(201816) P.R.C

