



Continuous inkjet printer
Right on the coding

B6040

BROCHURE



Clear, beautiful, stable printing



“B6040”Series
Continuous inkjet
Small character coding

GET CODING



- The B6040 heavy-duty continuous ink jet (CIJ) printer is designed to deliver high quality codes even in the harshest environments onto virtually any surface and product.
- The B6040 is compatible with Industry 4.0 standards. Independent R&D operating system, greatly enhance boot speed, reducing the instability due to other operating system brings to.
- CYCJET's maintenance-free ink system is equipped with imported print heads technology utilising CYCJET inks provides clear, readable text, graphics and barcodes while ensuring regulatory compliance.

Codes to create a lasting impression



Manual testing: direct manipulation of individual ink system valves and pumps close through the menu, easier to judge the failure, then prevent unnecessary maintenance costs.

Ink system: simple drawer intelligent ink system, ensure the stability of ink-system running, greatly improving the conveniences of maintenance.

Refill system: Ink refill system, refill and running at same time, No need to replace the ink tank, saving running cost.

🎯 A complete solution

Our services are designed to provide operational insight so you can eliminate downtime and maximise production efficiency

Operational support

No matter where you are, you can receive excellent after-sales service. We provide high-quality assistance manuals and instructional videos, as well as remote guidance from technical experts. 24X7 online service ensures that we can be with you when you need us the most.

Automatic code inspection

Ensure that every code leaving the factory exists and is correct, and save operator time. With the CYCJET visual control system, you can automate code checking to verify the presence, location, and readability of code.

Control software

Minimise errors using CYCJET's software. Control your product codes from a central location and streamline product changeovers. CYCJET's software uses standard communication protocols and can be integrated into existing ERP systems.

Smart production

The B6040 high-resolution inkjet printer can be integrated into any production line, no matter how complex your production environment is, the B6040 can help you improve production efficiency.



Item	Model	B6040
Nozzles		32dots
Nozzle Size		40/50/60/70u
Operation Interface		Touch Screen
Printing Lines		1-5 line
Printing Fonts		Customized Fonts Supported
Printing Height		1.2-15mm
Printing Speed		Max 345m/min
Ink System		Auto Self-cleaning
Ink Supply Method		Ink Tank, Ink Cartridge(optional)
Program		Standard, High Speed (optional)
Language		Multi Languages
Ink Color		Black, Blue, Red
Protection Degree		Ip55 Industrial Protection
External Interface		USB, Ethernet, RS232, Alarm Light
Power Supply		100-240V, 50/60Hz
Packing		56*48*68cm, 32.0kg

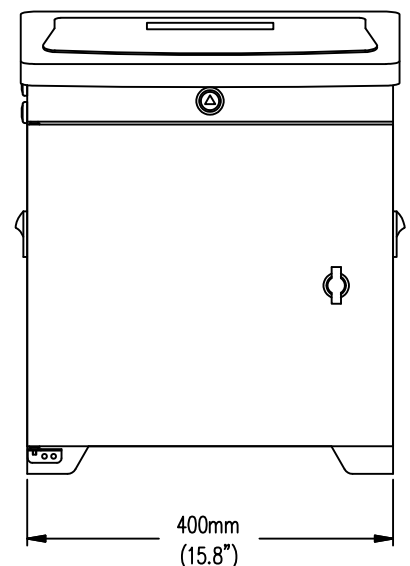
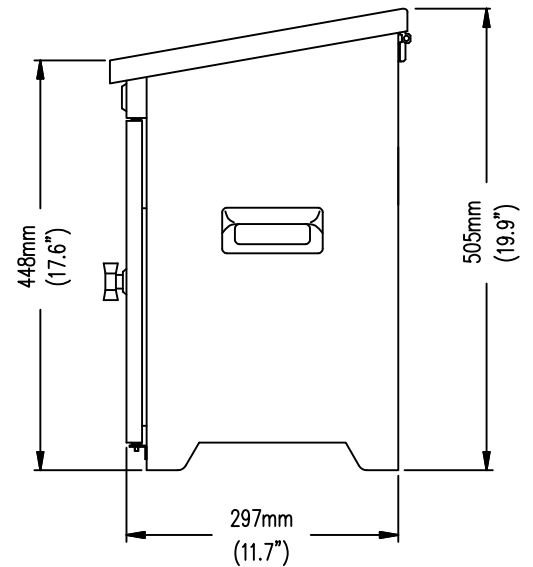



Contact Us

Web: www.cycjet.com

TEL: +86-21-59970419

FAX: +86-21-59971610

Email: service@cycjet.com

ADD: 1/F, BLDG. 4, NO. 333 HUAGAO RD., HUATING
IND. ZONE, SHANGHAI(201816) P.R.C

